

Dalia-FS 170x80

PREDINSTALACIJA
PREINSTALLATION
VORINSTALLATION

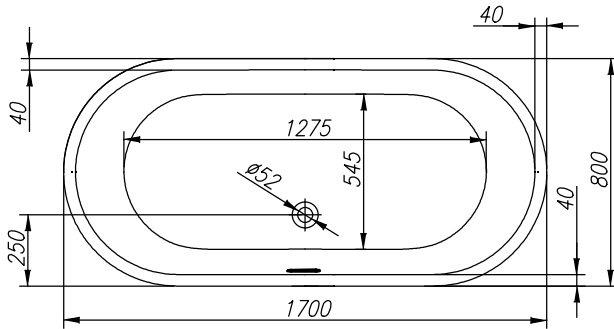
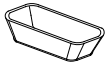
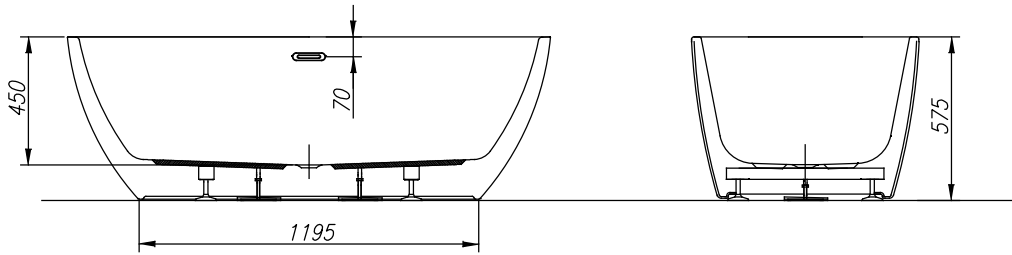

275 L

VOLUMEN
VOLUMEN
VOLUME
VOLUMEN

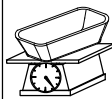

61 kg

TEŽA
TEŽINA
WEIGHT
GEWICHT

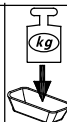

435 kg

MAX. OBREMENITEV
MAX. OBTEREČENJE
MAX. LOAD
MAX. BELASTUNG

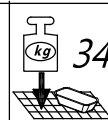

340 kg/m²

OBREMENITEV TAL
OBTEREČENJE PODA
FLOOR LOAD
BODENBELASTUNG



- Prostor za odtok Ø 50 mm
- Mjesto za odtok Ø 50 mm
- Drain spot Ø 50mm
- Abflussplatz Ø 50 mm

*priporočilo za vgradnjo
preporuka za ugradnju
installation recommendation
Einbauempfehlung*

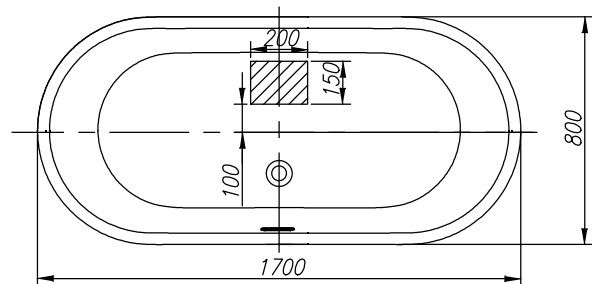

Samostoječa FS kopalna kad - navodilo za vgradnjo
FS samostoječa kada - upute za ugradnju
FS freestanding bathtub - installation instructions
FS Freistehende Badewanne - Einbauanleitung

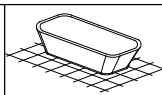

Nr. MK 44

DALIA-FS 170x80

**V NAVEDENO KOPALNO KAD NE VGRAJUJEMO ARMATUR ZA POLNENJE KADI
U NAVEDENU KUPAONSKU KADU NE UGRAĐUJEMO ARMATURE ZA PUNJENJE KADE
WE DO NOT INSTALL TUB FILLING FITTINGS IN THE GIVEN BATHTUB
WIR INSTALLIEREN KEINE WANNENFÜLLSTÜTZE IN DIE ANGELEGEBENE BADEWANNE**

2/2

DALIA-FS 170x80

**V NAVEDENO KOPALNO KAD NE VGRAJUJEMO MASAŽNIH SISTEMOV
U NAVEDENU KUPAONSKU KADU NE UGRAĐUJEMO MASAŽNIH SISTEMOV
WE DO NOT INSTALL MASSAGE SYSTEMS IN THE GIVEN BATHTUB
IN DER ANGELEGEBENEN BADEWANNE WERDEN MASSAGESYSTEMEN NICHT EINGEBAUT**